

VEXTADOMY

VEXTA GROW

rostoucí domy

Dům je od počátku pečlivě navržen tak, aby plnil měnící se potřeby klienta v čase. Do stavby domu VEXTA GROW tedy nemusíte investovat víc, než potřebujete v době, kdy s vlastním bydlením začínáte. Přístavby dalších modulů řešíte až ve chvíli, kdy je opravdu potřebujete. Vše je navrženo tak, aby dům mohl „růst“ i za provozu. Hotovo je během pár týdnů.





VEXTA GROW | schéma kladení

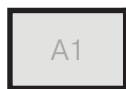

modul A1

dispozice 1+kk
půdorysné rozměry 8 x 5,5 m
UŽITNÁ PLOCHA 33,1 m²

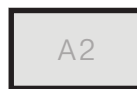

modul A2

dispozice 1+kk
půdorysné rozměry 9 x 5,5 m
UŽITNÁ PLOCHA 37,8 m²



modul A1/A2+B

dispozice 2+kk
půdorysné rozměry 12/13 x 5,5 m
UŽITNÁ PLOCHA 49,8/54,5 m²



modul A1/A2+B+C

dispozice 3+kk
půdorysné rozměry 16/17 x 5,5 m
UŽITNÁ PLOCHA 66/70,7 m²



modul A1/A2+C+D1

dispozice 3+kk
půdorysné rozměry 13,5/14,5 x 9,5 m
UŽITNÁ PLOCHA 72,7/77,4 m²



modul A1/A2+B+B+C

dispozice 4+kk
půdorysné rozměry 20/21 x 5,5 m
UŽITNÁ PLOCHA 82,6/87,3 m²



modul A1/A2+B+C+D2

dispozice 4+kk
půdorysné rozměry 17,5/18,5 x 9,5 m
UŽITNÁ PLOCHA 89,5/94,2 m²



modul A1/A2+B+C+D1

dispozice 4+kk
půdorysné rozměry 13,5/14,5 x 13,5 m
UŽITNÁ PLOCHA 89,3/94 m²

modul A1/A2+B+B+C+D2

dispozice 5+kk
půdorysné rozměry 21,5/22,5 x 9,5 m
UŽITNÁ PLOCHA 106,2/110,9 m²



modul A1/A2+B+C+D2+G+T

dispozice 4+kk
půdorysné rozměry 25,5/26,5 x 9,5 m
UŽITNÁ PLOCHA 131,6/136,3 m²



VEXTA GROW

modul A1

užitná plocha 33,1 m² | zastavěná plocha 44 m² | půdorysné rozměry 8 x 5,5 m

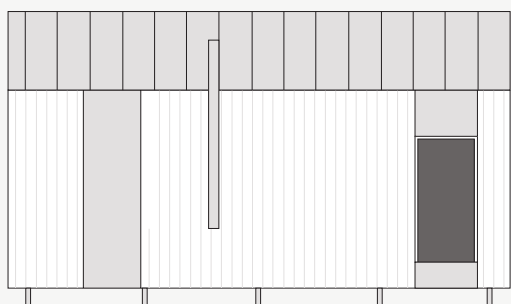
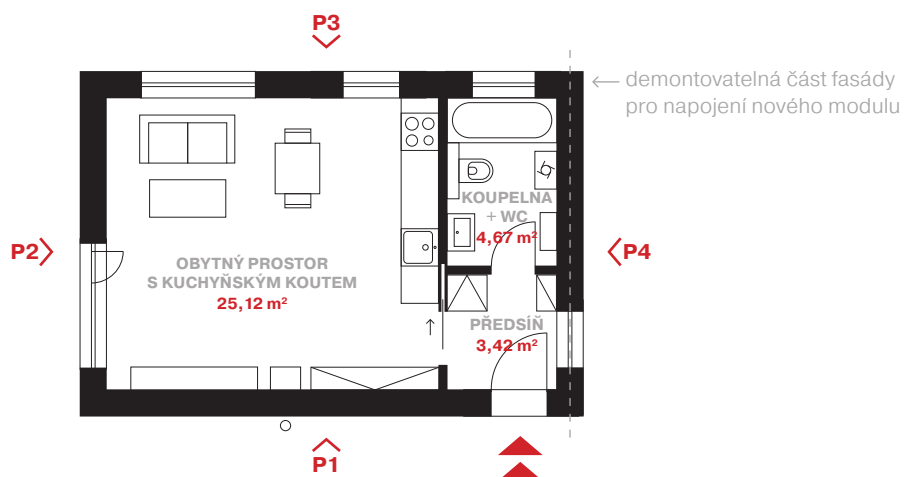

POHLED P1

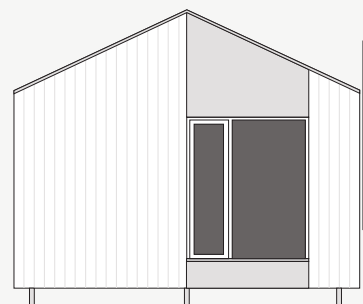

POHLED P2

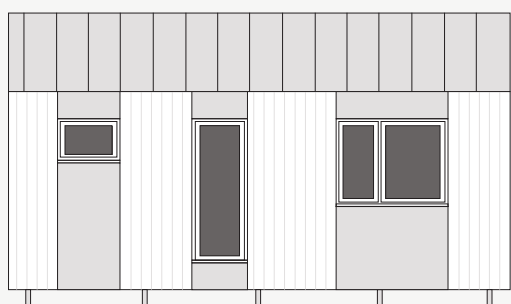

POHLED P3



POHLED P4

VEXTA GROW

modul A2

užitná plocha 37,8 m² | zastavěná plocha 49,5 m² | půdorysné rozměry 9 x 5,5 m

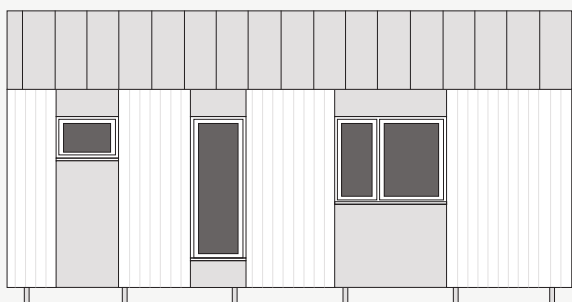
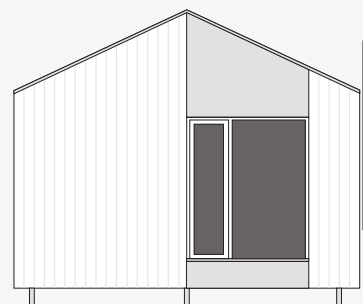
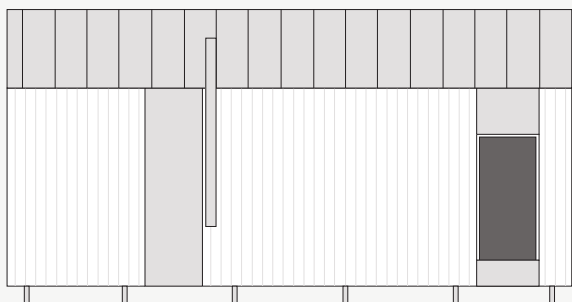
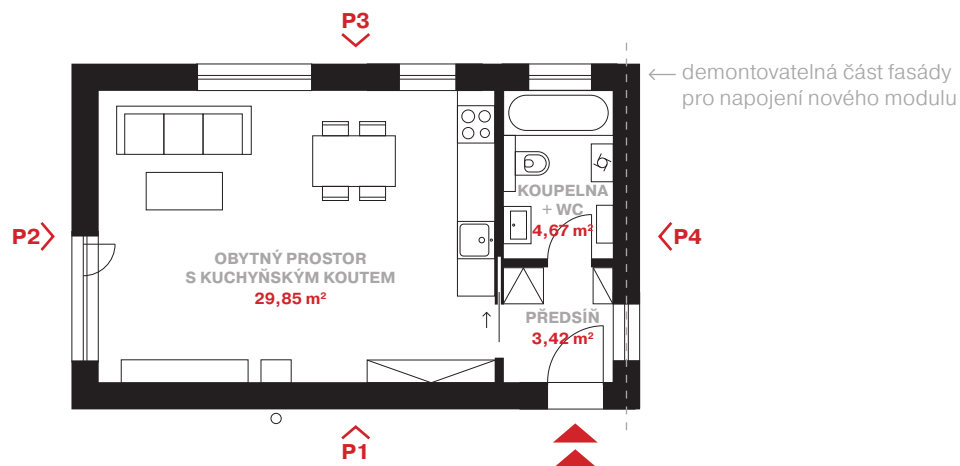

VEXTA GROW

modul B

užitná plocha 16,6 m² | zastavěná plocha 22 m² | půdorysné rozměry 4 x 5,5 m

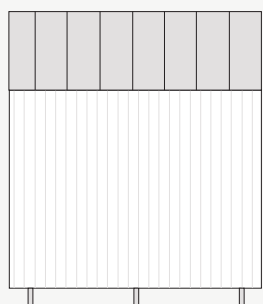
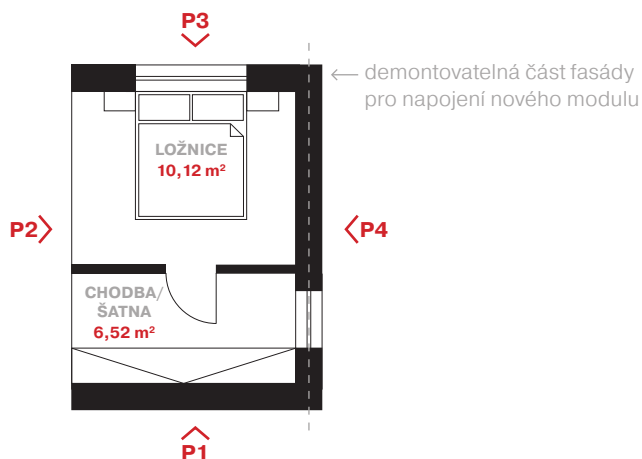

POHLED P1

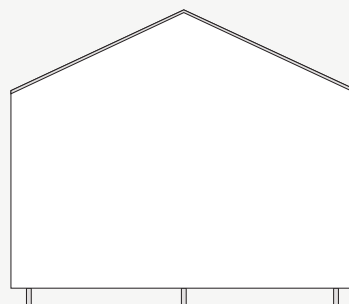

POHLED P2

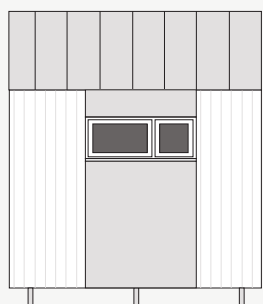

POHLED P3

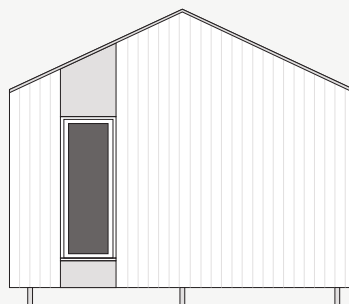

POHLED P4

VEXTA GROW

modul C

užitná plocha 16,2 m² | zastavěná plocha 22 m² | půdorysné rozměry 4 x 5,5 m

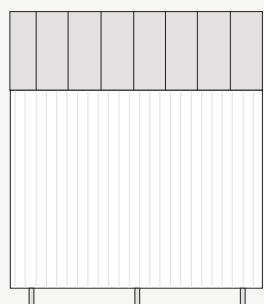
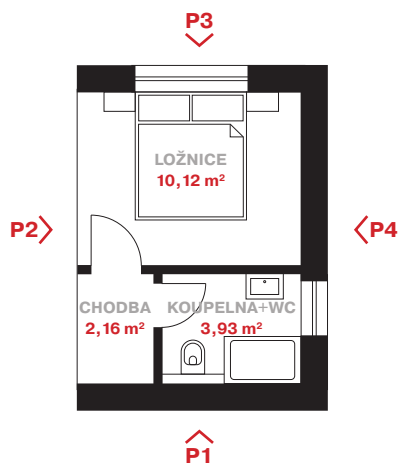

POHLED P1

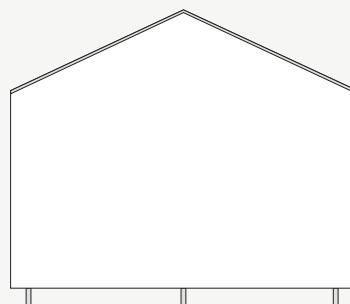

POHLED P2

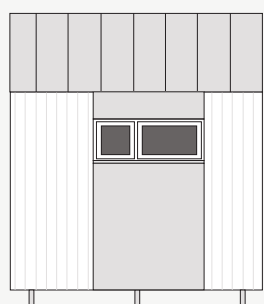

POHLED P3

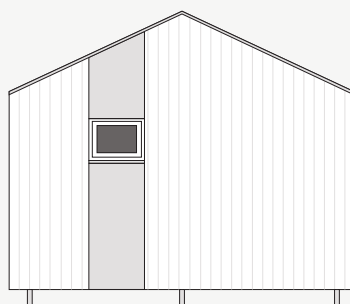

POHLED P4

VEXTA GROW

modul D1

užitná plocha 23,3 m² | zastavěná plocha 30,3 m² | půdorysné rozměry 5,5 x 5,5 m

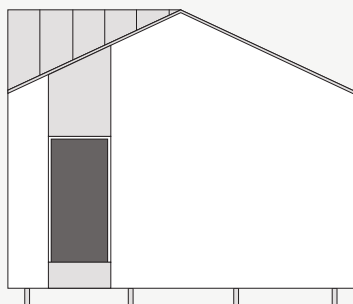
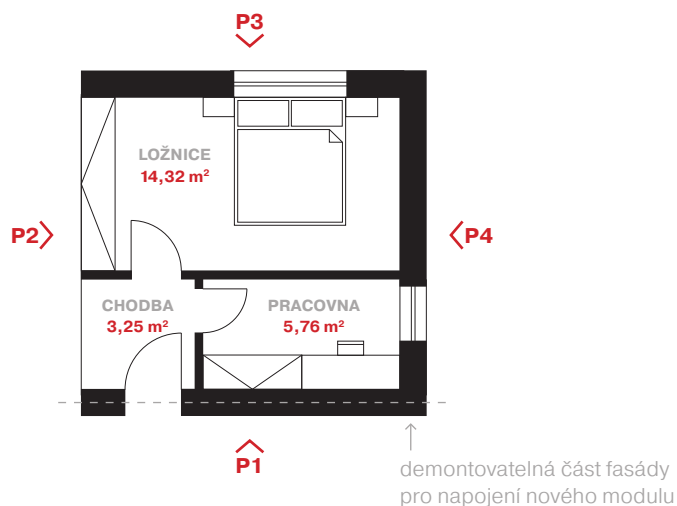

POHLED P1

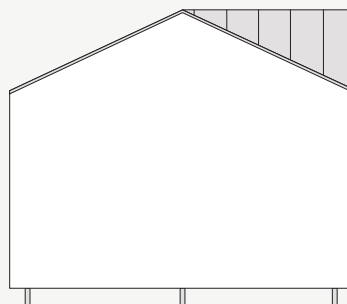

POHLED P2

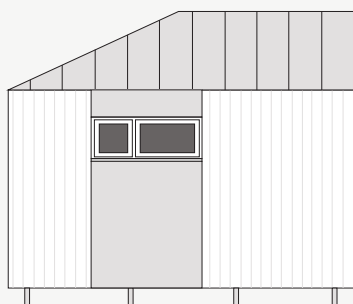

POHLED P3

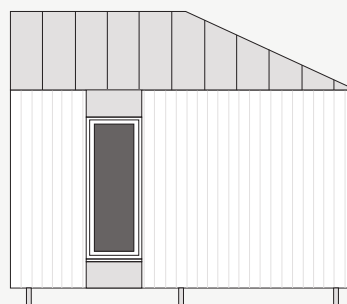

POHLED P4

VEXTA GROW

modul D2

užitná plocha 23,6 m² | zastavěná plocha 30,3 m² | půdorysné rozměry 5,5 x 5,5 m

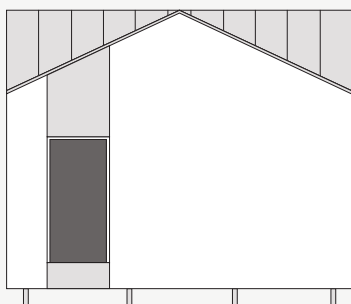
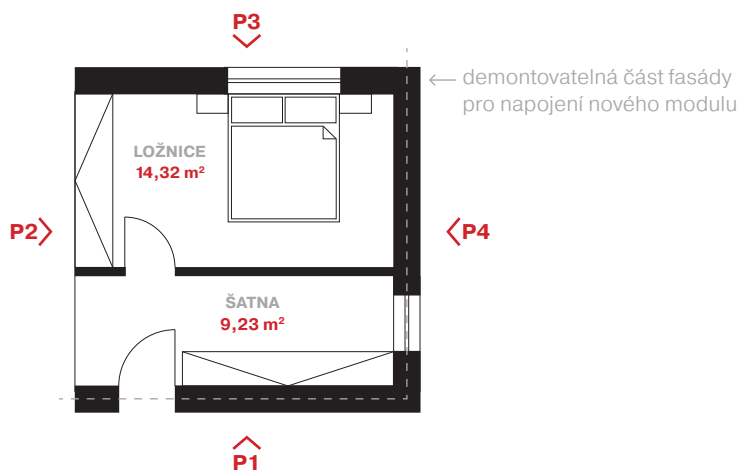

POHLED P1

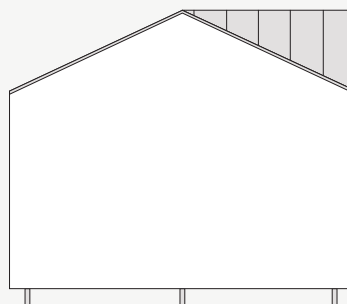

POHLED P2

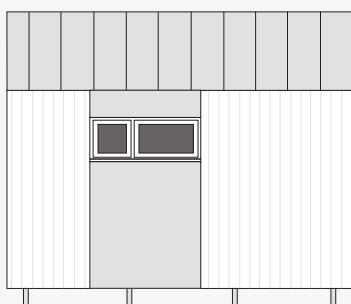

POHLED P3

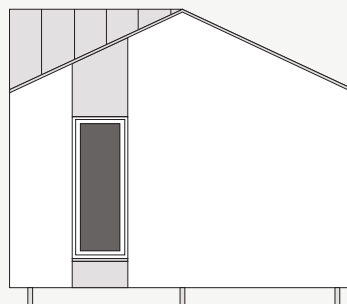

POHLED P4

VEXTA GROW

modul T

užitná plocha 20,7 m² | zastavěná plocha 22 m² | půdorysné rozměry 4 x 5,5 m

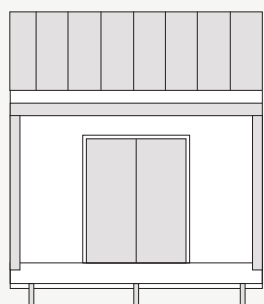
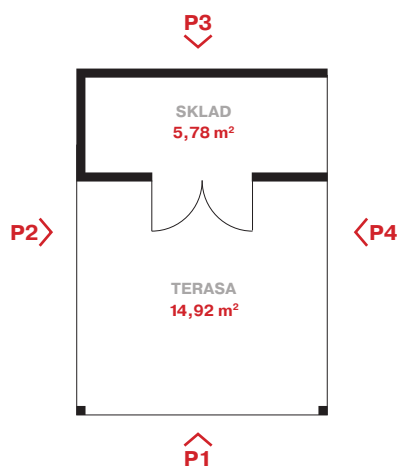

POHLED **P1**

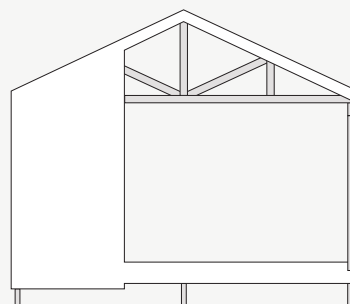

POHLED **P2**

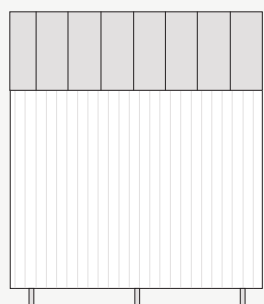

POHLED **P3**

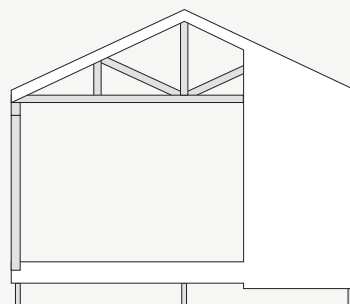

POHLED **P4**

VEXTA GROW

modul G

užitná plocha 21,4 m² | zastavěná plocha 22 m² | půdorysné rozměry 4 x 5,5 m

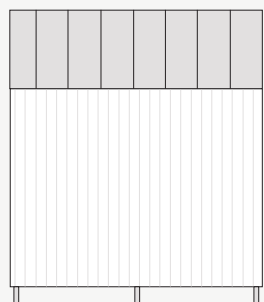
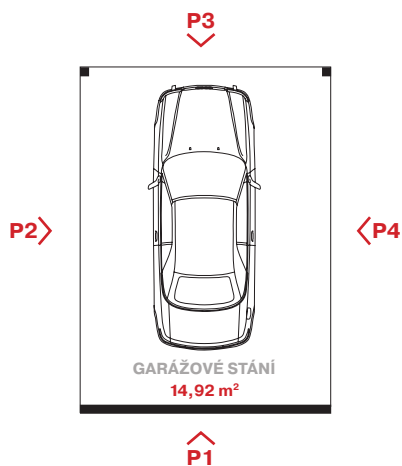

POHLED P1

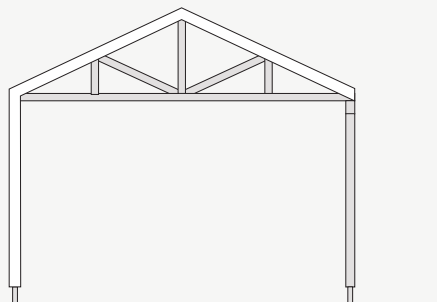

POHLED P2

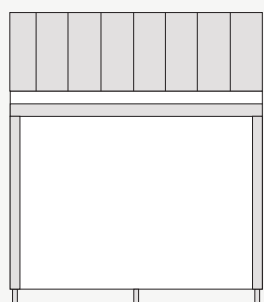

POHLED P3

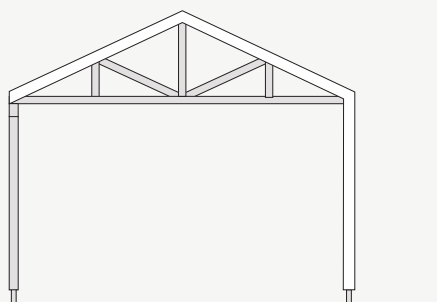

POHLED P4